

GLUTÄCK®

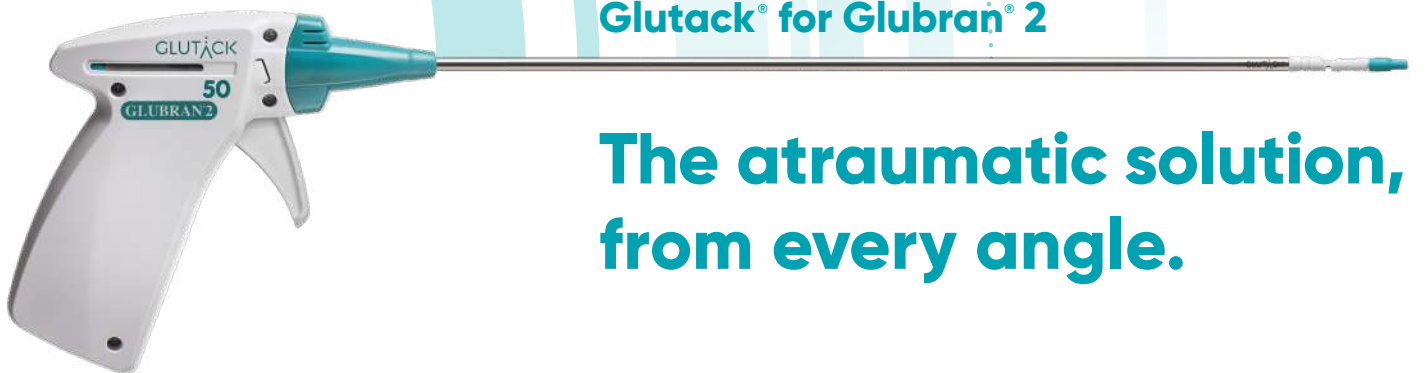

Glutack® for Glubran® 2



**The atraumatic solution,
from every angle.**

GLUBRAN 2



GEM SOLUTION
COMES FROM
EVOLUTION.

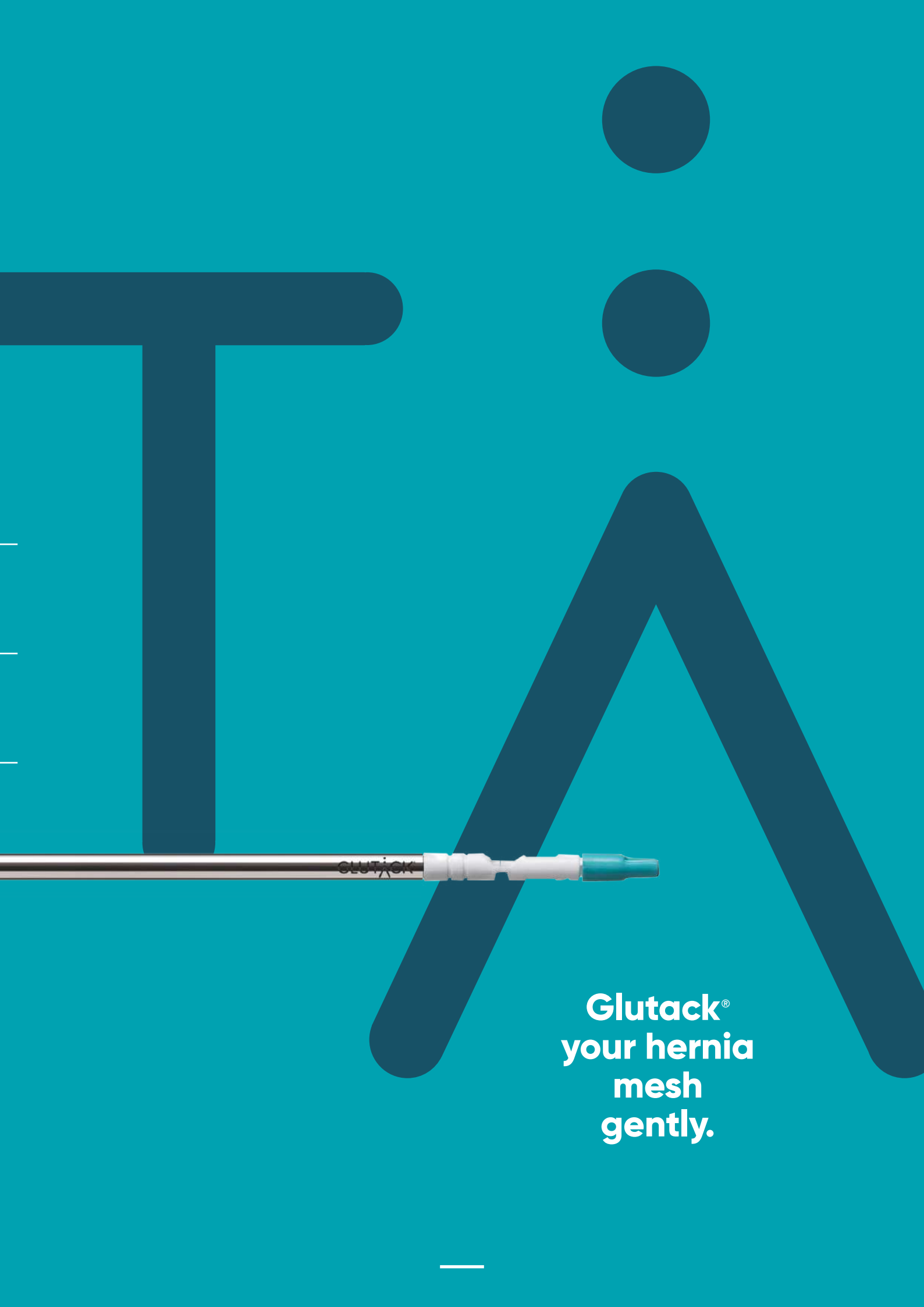

Glutack[®]
your hernia
mesh
gently.



GLUTACK®

A total evolution.

Designed with years of inherited experience of Glubran® 2 in atraumatic laparoscopic and laparotomic mesh fixation¹⁻²⁹.

Glutack® is a user-friendly device for the atraumatic laparoscopic fixation of hernia mesh. Providing precise and consistent delivery of Glubran® 2 (NBCA+MS) with every pull of the trigger²⁴, to minimize surgical complications and the potential pain associated with the use of tacks and staples. Improving surgical outcomes and reducing healthcare costs¹⁻³³.

➤ **One Glutack® is dispensed with every pull of the trigger**



Glutack® + Glubran® 2 = 1 high performance adhesive tack

- **No change in clinical practice: delivery method is similar to traditional mesh fixation devices**
- **Glubran® 2 is effective in repairing hernias with less post-op pain, less complications, less recurrences and cost-effective is largely documented¹⁻³³**
- **Improves patient safety^{1,2,6,8} and surgeon confidence¹**
- **Keeps the mesh in place respecting the natural tissue ingrowth^{9,10}**

BUILDING THE

**FLU
TU
RE**



Atraumatic.

Versatile.

Multipurpose.

Glutack® + Glubran® 2 = 1 high adhesive tack



GLUBRAN® 2



Synthetic biodegradable¹¹ cyanoacrylate adhesive modified by the addition of a monomer synthesized by the manufacturer GEM.

Polymerizes quickly in contact with live tissue and a wet environment⁸ creating a thin and elastic film¹² having high tensile strength which guarantees strong adhesion to the tissues^{10,13}.

Ready for use¹⁴⁻¹⁶ a high adhesive, sealant with haemostatic¹⁷ and bacteriostatic properties. Effective antiseptic barrier against the most diffused infective and pathogenic agents during the surgical intervention^{11,18,19}.

Class III medical device authorized since 1998 in open, laparoscopic surgery and endovascular uses²⁰.



GLUTÄCK®

Evolution through revolution.

0° to 90° exclusive articulating tip





**The gentle
power of
the drop.**



SAFE

- No clips or tacks: no tissue penetration, no nerve entrapment, no vessel damage^{6,21} (Fig.1)
- Less post-op pain^{6,33} (Fig.2)
- Reduces post-op complications^{1,2,6,23}
- Adhesive delivery controlled at all times – no drips²⁴
- Tip designed to avoid clogging and sticking²⁴
- Fixation even in high risk anatomical locations: around the Triangle of Doom, Triangle of Pain and close to the Diaphragm



STRONG

- High shear strength equivalent to the current fixing methods: more than 9 N/cm² Glutack^{®13} (Fig.3/5a)
- High peel force to remove the fixed mesh: 6N/cm² Glutack^{®22} (Fig.5b)
- No significant difference in the strength of parietal ingrowth between sutures²⁵, absorbable/permanent tacks and Glubran 2^{®10} (Fig.4)



FAST²⁴

- Very quick device preparation < 1 min
- Rapid, controlled Glutack[®] delivery
- Each precision Glutack[®] adheres the mesh to the tissue immediately



PRECISE²⁴

- Accurately controlled, repeatable Glutack[®] volume (0.0125 ml/drop)
- No product wastage



VERSATILE²⁴

- 3 different sizes: containing 25, 40 or 50 Glutacks depending on mesh size / procedure requirement
- Articulating tip system to reach difficult areas



FLEXIBLE²⁴

- Multiple angles of approach facilitated by articulating tip system (0° to 90°)
- Glutack[®] can be delivered at any angle
- Eliminates the need for contralateral ports



INTUITIVE²⁴

- Simple "point and shoot" design
- Handle geometry provides user comfort and multiple grip options
- Audible and visual indicators confirm Glutack[®] delivery and number of Glutacks left
- Allowing you to deploy Glutacks perpendicular to the mesh and abdominal wall

REALLY ATRAUMATIC

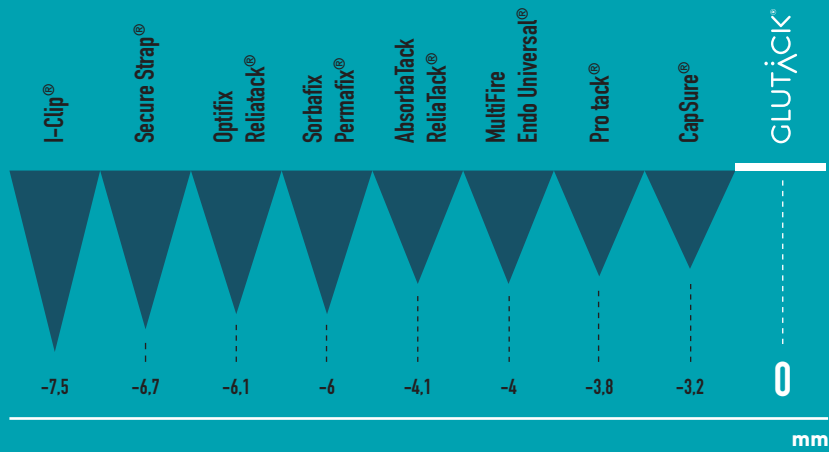

(Fig.1)

TISSUE PENETRATION (mm)^{21, 30}

LESS PAIN

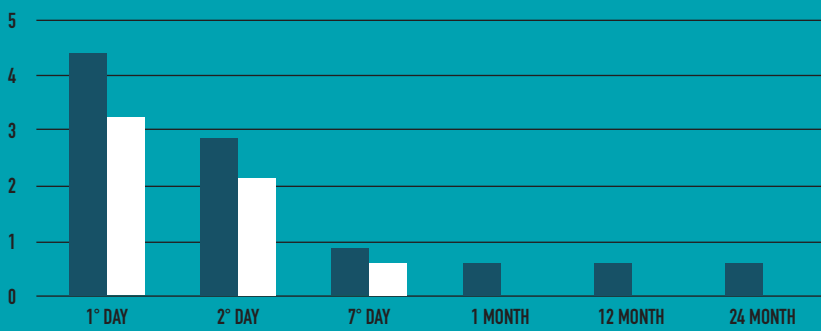

(Fig.2)

CLIPS
GLUBRAN®

EVALUATION OF POSTOPERATIVE PAIN INTENSITY BY VAS SCALE⁶
(modified by Burza A. et al. 2014).

ONE GLUTACK COMPARED TO COMPETITOR DEVICE

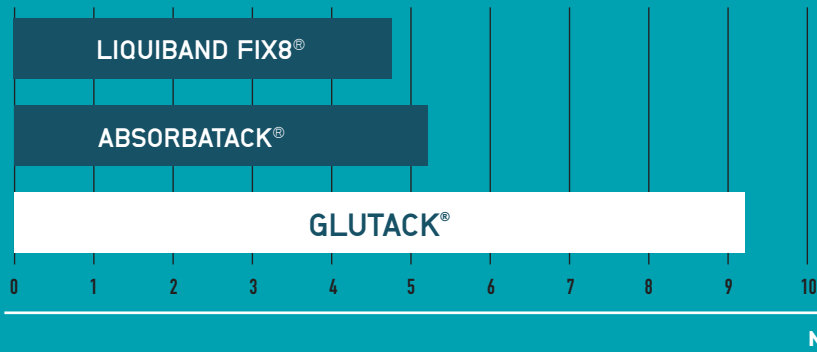

(Fig.3)

PRE-CLINICAL SHEAR STRENGTH EVALUATION IN AN IN VITRO MODEL FOR PP-DYNAMESH FIXATION¹³.

STRENGTH OF PARIETAL INGROWTH - 12 MONTHS

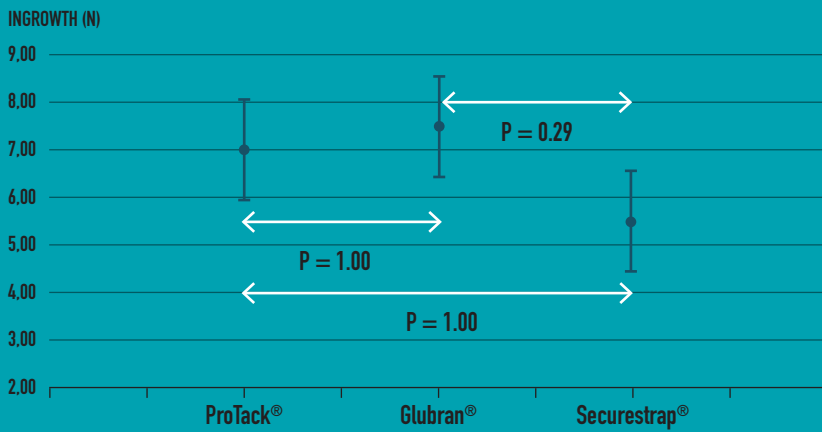

(Fig.4)

modified by Harsløf S. et al. 2017¹⁰.

GLUTACK® STRENGTH TEST^{13,22}

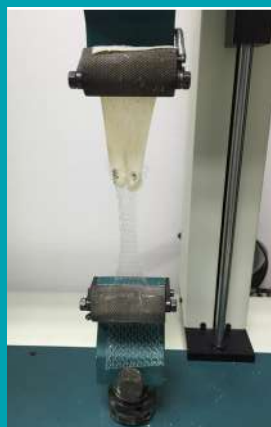

SHEAR 9N/CM²

(a)



PEELING 6N/CM²

(b)

(Fig.5a/5b)

GLUTACK®

Proven Efficacy.

Glutack® in action.

Repair inguinal hernia



Laparoceles



Reduce trauma by a combined mesh fixation technique

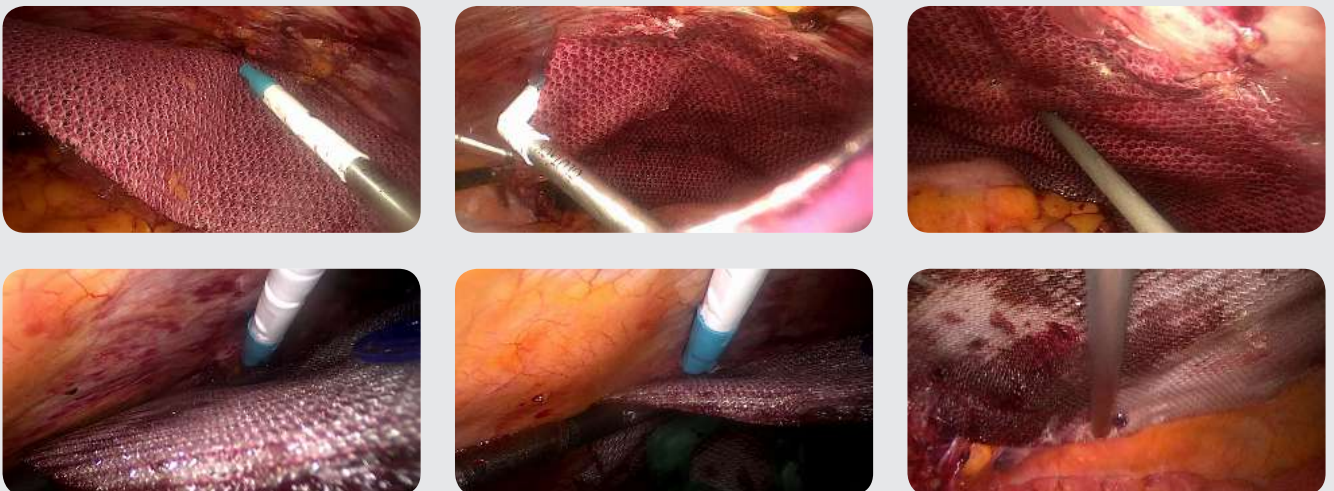

Bibliography

1. Kukleta JF, Freytag C, Weber M. Efficiency and safety of mesh fixation in laparoscopic inguinal hernia repair using n-butyl cyanoacrylate: long-term biocompatibility in over 1,300 mesh fixations. *Hernia*. 2012 Apr;16(2):153-62.
2. Testini M, Lissidini G, Poli E, Gurrado A, Lardo D, Piccinni G. A single-surgeon randomized trial comparing sutures, N-butyl-2-cyanoacrylate and human fibrin glue for mesh fixation during primary inguinal hernia repair. *Can J Surg*. 2010 Jun;53(3):155-60.
3. Grasso G., Florio G., Mari A., Del Papa M., Carni D.. Trattamento dell'ernia inguinale con procedura IPPM (intraperitoneal polyvinylidene fluoride polypropylene mesh): tecnica personale. *Osp. Ital Chir*. Luglio Settembre 2010.
4. Paajanen H, Kössi J, Silvasti S, Hulmi T, Hakala T. Randomized clinical trial of tissue glue versus absorbable sutures for mesh fixation in local anaesthetic Lichtenstein hernia repair. *Br J Surg*. 2011 Sep;98(9):1245-51.
5. Ladurner R, Drosse I, Seitz S, Plitz W, Barbaryka G, Siebeck M, Bürklein D, Kirchhoff C, Buhman S, Mutschler W, Schieker M, Mussack T. Tissue attachment strength and adhesion formation of intraabdominal fixed meshes with cyanoacrylate glues. *Eur J Med Res*. 2008 May26;13(5): 185-91
6. Burza A, Avantiore R, Curinga R, Santini E, Delle Site P, Stipa F. Comparison between two different mesh fixation methods in laparoscopic inguinal hernia repair: tacker vs. Synthetic cyanoacrylate glue. *Minerva Chir*. 2014 Dec;69(6):321-329.
7. Eldabe Mikhail A, Palomo Luquero A, Reoyo Pascual JF, Seco Gil JL. Prosthetic material fixation in open inguinal hernioplasty: suture vs. synthetic glue. *Cir Esp*. 2012 Aug-Sep;90(7):446-52.
8. Losi P, Burchielli S, Spiller D, Finotti V, Kull S, Briganti E, Soldani G. Cyanoacrylate surgical glue as an alternative to suture threads for mesh fixation in hernia repair. *J Surg Res*. 2010 Oct;163(2):e53-8.
9. Harsløf S, Krum-Møller P, Sommer T, Zinther N, Wara P, Friis-Andersen H. Effect of fixation devices on postoperative pain after laparoscopic ventral hernia repair: a randomized clinical trial of permanent tacks, absorbable tacks, and synthetic glue. *Langenbecks Arch Surg*. 2018 Jun;403(4):529-537.
10. Harsløf S, Zinther N, Harslof T et al (2017) Polypropylene-mesh properties and type of anchoring do not influence strength of parietal ingrowth. *Langenbeck's ArchSurg* 402:1047–1054.
11. Montanaro L, Arciola CR, Cenni E, Ciapetti G, Savioli F, Filippini F, Barsanti LA. Cytotoxicity, blood compatibility and antimicrobial activity of two cyanoacrylate glues for surgical use. *Biomaterials*. 2001 Jan;22(1):59-66.
12. Haghpanah S, Vafafar A, Golzadeh MH, Ardeshiri R, Karimi M. Use of Glubran 2 and Glubran tissue skin adhesive in patients with hereditary bleeding disorders undergoing circumcision and dental extraction. *Ann Hematol*. 2011 Apr;90(4):463-8
13. GEM internal test report 140415: Glutack Lap Shear strength evaluation done with different porous meshes.
14. Garcia-Vallejo L, Couto-Gonzalez I, Concheiro-Coello P, Brea-Garcia B, Taboada-Suarez A. Cyanoacrylate surgical glue for mesh fixation in laparoscopic total extraperitoneal hernia repair. *Surg Laparosc Endosc Percutan Tech*. 2014 Jun; 24(3):240-3.
15. Hosseini SM, Rasekhi AR, Zarenezhad M, Hedjazi A. Cyanoacrylate glue dressing for hypospadias surgery. *N Am J Med Sci*. 2012 Jul;4(7): 320-2.
16. Ahmed E, Lasheen, Adel M, Tolba, Hany Mohamed, Hatem Mohammed, Nadia A. Smaeil. Laparoscopic Inguinal Hernia Repair with Closure of Hernial Defect and Central Mesh Fixation Using Glubran 2. *Surgical Science*, 2013, 4, 554-557.
17. Kull S, Martinelli I, Briganti E, Losi P, Spiller D, Tonlorenzi S, Soldani G. Glubran2 surgical glue: in vitro evaluation of adhesive and mechanical properties. *J Surg Res*. 2009 Nov;157(1):e15-21
18. Karatepe O, Ozturk A, Koculu S, Cagatay A, Kamali G, Aksoy M. To what extent is cyanoacrylate useful to prevent early wound infections in hernia surgery? *Hernia*. 2008 Dec;12(6):603-7.
19. Howell JM, Bresnahan KA, Stair TO, Dhindsa HS, Edwards BA (1995) Comparison of effects of suture and cyanoacrylate tissue adhesive on bacterial counts in contaminated lacerations. *Antimicrob Agents Chemother* 39:559–560
20. Glubran 2 Technical Sheet - IFU Ver 11-2019
21. Reynvoet E, Berrevoet F. Pros and cons of tacking in laparoscopic hernia repair. *Surg Technol Int*. 2014 Nov;25:136-40
22. Villalobos R. et al. Laparoscopic ventral/incisional hernia repair with only glue mesh fixation using a new device: GLULAP experimental study. Poster presentation. Miami AHS-EHS 2018.
23. Koch CA, Greenlee SM, Larson DR, Harrington JR, Farley DR. Randomized prospective study of totally extraperitoneal inguinal hernia repair: fixation versus no fixation of mesh. *JLS*. 2006 Oct-Dec;10(4):457-60.
24. On GEM data file.
25. Dilege E, Devenci U, Erbil Y, Dinççağ A, Seven R, Ozarmagan S, Mercan S, Barbaros U. N-butyl cyanoacrylate versus conventional suturing for fixation of meshes in an incisional hernia model. *J Invest Surg*. 2010 Oct;23(5):262-6.
26. Kukleta JF. Causes of recurrence in laparoscopic inguinal hernia repair. *J Minim Access Surg*. 2006 Sep;2(3):187-91.
27. Agresta F, Baldazzi GA, Ciardo LF, Trentin G, Giuseppe S, Ferrante F, Bedin N. Lightweight partially absorbable monolament mesh (polypropylene/poliglecaprone 25) for TAPP inguinal hernia repair: initial experience. *Surg Laparosc Endosc Percutan Tech*. 2007 Apr;17(2):91-4.
28. Garcia-Pastor P, Torregrosa A, Carvajal N, Garcá R, A'lvarez E, Blasco R, B-Lledo J, Garcá-a-Granero E. Nebulized cyanoacrylate for prostheses fixation in Rives-type eventroplasty. Usefulness of Mri-visible meshes for safety control. *P-1309- Hernia (2018) 22 (Suppl 1): S94–S189*.
29. Panel P, Soffray F, Roussillon E, Devins C, Brouziyne M, Abramowicz S. Glue mesh fixation: Feasibility, tolerance and complication assessment. Results 24 months after laparoscopic sacrocolpopexy. *J Gynecol Obstet Hum Reprod*. 2017
30. Data on official products catalogues.
31. "A new device for mesh fixation with cyanoacrylate glue in laparoscopic tAPP repair for inguinal hernia" Fantacci R, Cobuccio L, Galatioto C.; Video-Poster presentation, 29° Congresso di Chirurgia dell'Apparato Digerente 28-29 Nov. 2018.
32. Laparoscopic Repair of Ventral Hernia: A new non-traumatic method of Fixation. Nasti G. IV International Medical Film Festival Ryn Poland Ist Polish-French Joint Meeting of Hernia Clubs 22-24 Nov.2018.
33. Mitura K, Garnysz K, Wyrzykowska D, Michałek I. The change in groin pain perception after transabdominal preperitoneal inguinal hernia repair with glue fixation: a prospective trial of a single surgeon's experience. *Surg Endosc*. 2018 Oct;32(10):4284-4289.

Assembly and use instructions

The device must be prepared and activated properly in order to ensure correct operation.

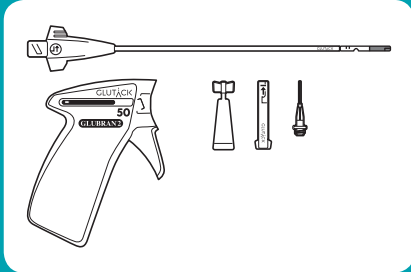

1) On the serving table, place the components of the GLUTACK® device (catheter, handpiece, cartridge, transfer tip) and a single dose vial of Glubran® 2 surgical device.

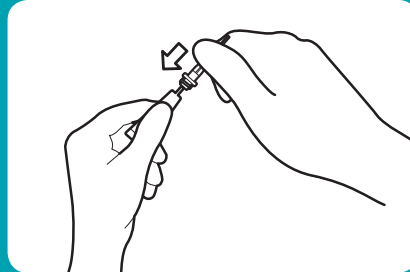

2) Open the single dose of Glubran® 2. Insert the transfer tip onto the single dose vial, gripping it close to the neck, and apply adequate pressure to allow the tip to be inserted.
Warning: do not press on the bottom of the single dose to prevent the product from leaking out.

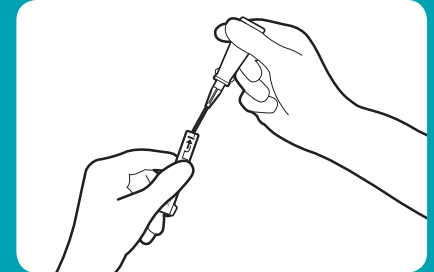

3) Holding the transparent plastic cartridge in an upright position (upwards black arrow), insert the transfer tip into the small opening. Gradually fill the cartridge by carefully pressing on the body of the single dose vial until the product reaches the black line. **When the filling is complete, check that there are no air bubbles inside the cartridge.**

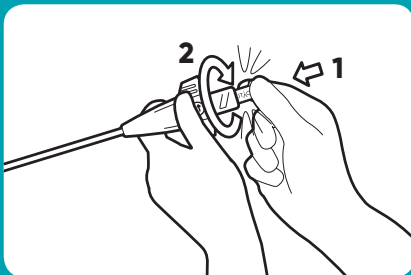

4) Insert the cartridge into the rear opening of the catheter (housing chamber) until the end of the stroke. When fully inserted, turn it clockwise 90° until you hear a click.

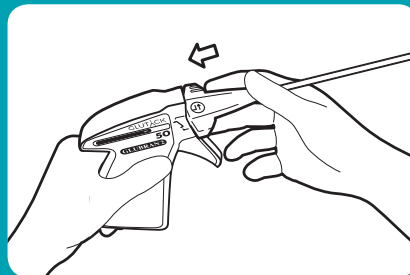

5) Take the handpiece with the left hand and the catheter with the right hand. Insert the hooking base (the green plastic part with the wings) into the handpiece, with the wings perpendicular to the handpiece.
Make sure that the symbol points upwards.

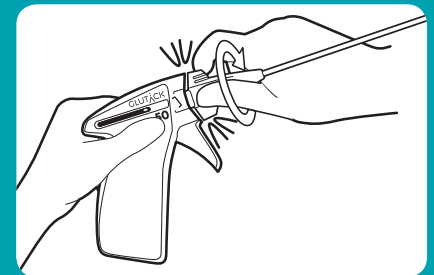

6) Turn clockwise by 90° up to the end of the stroke. At the sound of the click, the catheter is correctly assembled and the trigger mechanism automatically unlocks.

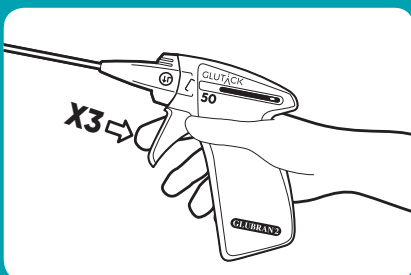

7) To make the device ready to use, release the first drop of Glubran® 2 by gently pressing the trigger 2-3 times.

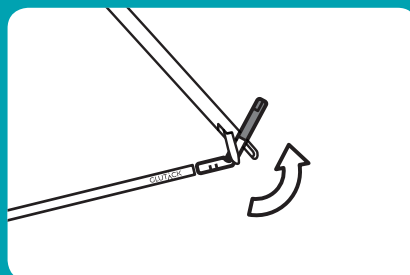

8) Inside the abdominal cavity, when necessary, grasp the articulated end in the specific groove with surgical clamp, orienting it upwards between 0° and 90° angle. To remove the device, passing through the trocar, return the articulated end to the linear position 0°.

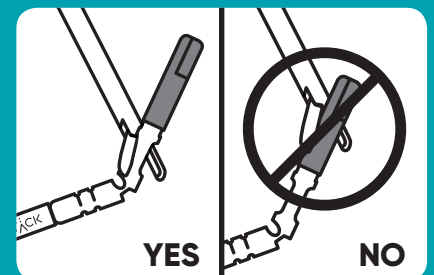

9) Inside the abdominal cavity do not grasp the green tip placed at the end of the device with surgical clamp.

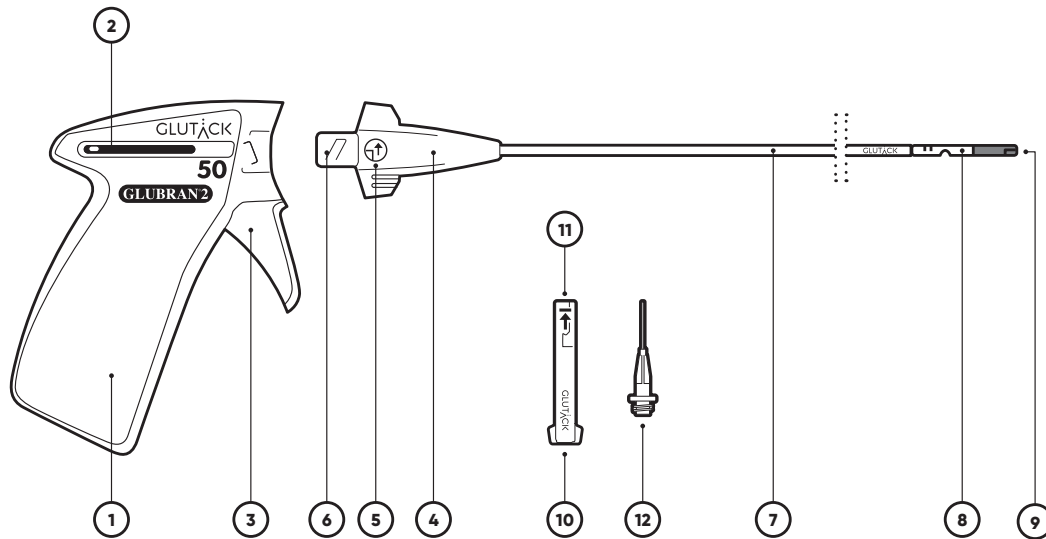

The sterile, latex free and single-use device consists of the following components:

- Handpiece (1) with label indicating the quantity of drops that can be dispensed; equipped with slider (2), which reveals the quantity of Glubran® 2 dispensed during the procedure, and the trigger (3) connected to the gear that comprises the precise delivery system of the drops.
- Rigid catheter (external diameter of 5 mm) composed of:
 - connection base (4) with the symbol showing the mounting direction (5) and loading chamber for the loading cartridge (6);
 - steel rod (7) inside which a small tube runs allowing the passage of Glubran® 2;
 - articulated and adjustable end, 0 ° to 90° (8), equipped with a tip, designed to be anti-adhesive and clog resistant (9).
- Loading cartridge for the Glubran® 2 in transparent plastic (10), pre-marked with symbols indicating the direction of insertion in the housing chamber and the loading level (11).
- Transfer tip to be used to fill the cartridge with Glubran® 2 (12).

Read always carefully the instructions for use (IFU) in the package leaflet.



GLUTÄCK®

For every single need.



3 different variants containing
25, 40 or 50 Glutacks depending on
mesh size / procedure requirement.

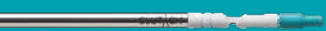

**SOLUTION
COMES FROM
EVOLUTION.**



Via dei Campi 2 - PO Box 427 - 55049 Viareggio (LU) Italy
Tel. +39 0584 389784/391388 - Fax +39 0584 397904
www.gemitaly.it - info@gemitaly.it